

*Luxura*

**V<sub>6</sub> V<sub>8</sub>**

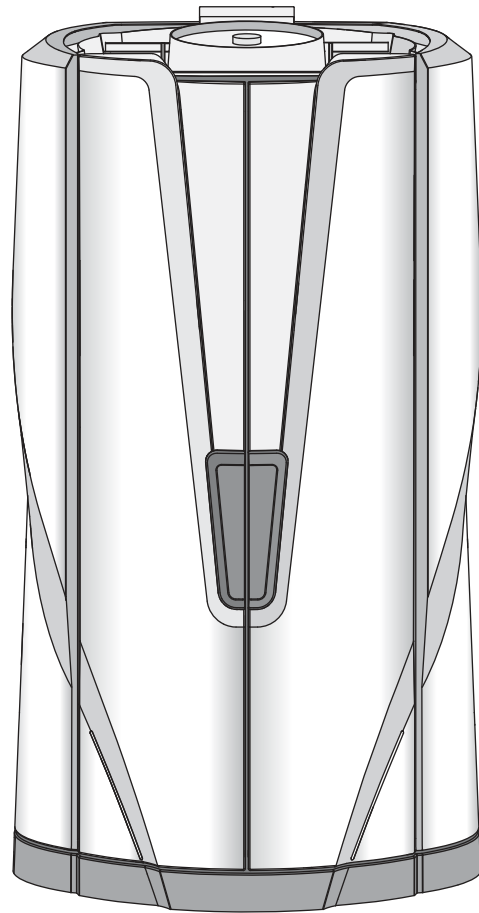

**USER  
MANUAL**

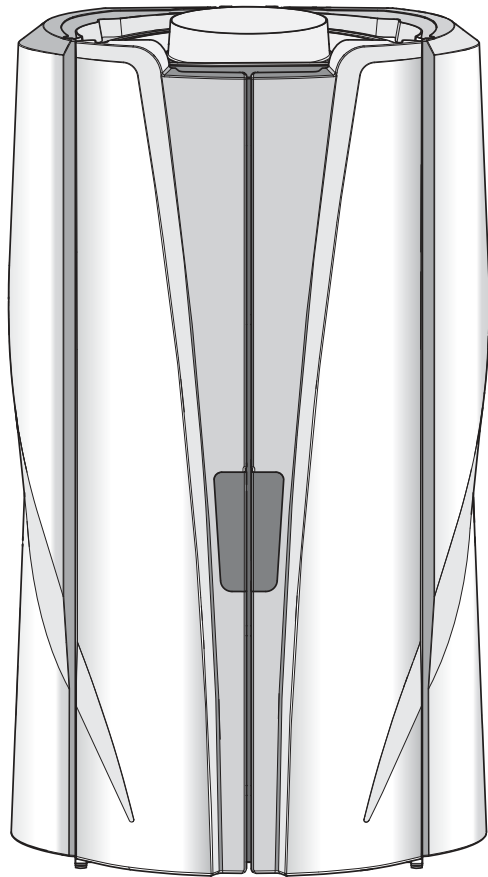

Congratulations on the purchase of your Hapro appliance. Your new appliance has been manufactured with the utmost care and attention and consists of high-quality parts. All Hapro appliances have been developed to give you the best possible tan, whilst complying with the strictest applicable European standards. *(original instructions)*

This manual provides the required information on warnings, instructions and assembly. You should use this manual for more than just the necessary appliance assembly and/or maintenance instructions; you need to familiarize yourself with all of the information provided. Persons who use the tanning appliance need to be informed and supervised, and it is your duty to make sure they receive proper assistance. Digital version at [www.hapro.com](http://www.hapro.com).

Lamp information .....	4
Operation .....	5
Symbols .....	14
Warranty policy .....	15
Declaration of Conformity .....	16

## Contents

# Lamp information

The lamps listed below are those that are installed as standard equipment at the factory. These standard lamps have been selected for optimal tanning results and to match the UV classification of your tanning unit. We recommend that when you replace a lamp you only use lamps of the type currently installed in your tanning unit and which are listed in the table below and on the identification plate. If you choose to install a different type of lamp, you must only use lamps that are marked with an equivalent code which indicates that the UV component falls within the equivalence range listed on the identification plate

LAMPS	ART NR	EQUIVALENT CODES	UV TYPE (EU)	UV TYPE (NON EU)
Maxlight XL 180W-R CE III	12818	180-R-(21-28)/(2-2,6)	3	2
Maxlight XL 180W-R High Intensive	12821	180-R-(86-114)/(6,7-9,1)	5	5
Maxlight XL 200W-R High Intensive S	18525	200-R-(83-111)/(6,8-9,2)	5	5
Maxlight XL 180W-R CE III S	18067	180-R-(21-28)/(1,7-2,3)	3	2
Maxlight XL 180W-R CE III E	27353	180-R-(26-34)/(2-2,8)	3	2
Maxlight XL 180W-R High Intensive E	27354	180-R-(106-141)/(6,9-9,3)	5	5
Maxlight XL 200W-R Ultra Intensive E	27355	180-R-(138-184)/(8,8-12)	5	5

- Note:
- The equivalent code is only applicable to low-pressure fluorescent lamps.
  - The total erythema is limited to 0.3 W/m<sup>2</sup>.

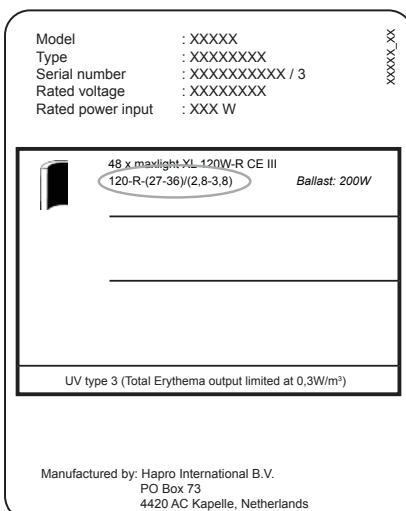

## Example:

On the example identification plate the equivalent codes for the installed lamps are circled.

The equivalent code for the canopy is 120-R-(27-36)/(2,8-3,8)

120 = the wattage of the lamp

R = the reflector type

(27-36) = the equivalence range for the total effective erythema

(2,8-3,8) = the equivalence range for the NMSC ratio

If you intend to install a new lamp, the wattage and reflector type must always match the equivalent code on the identification plate. The effective erythema and NMSC ratio must also match the specified range.

You may only use a lamp other than the recommended type if all of these criteria are met. You must also be aware that:

- The tanning unit is likely to be less effective in terms of tanning performance.
- The circuit protection for your tanning unit must be adapted because the electrical current consumption will have changed.
- The UV classification no longer matches the original classification shown on the identification plate.
- We will not necessarily honour warranty claims arising from the use of lamps other than those we recommend, because the technical operation of your tanning unit might be affected.

# Operation



- |    |             |
|----|-------------|
| 1  | Display     |
| 2  | Start/ Stop |
| 3  | Plus        |
| 4  | Min         |
| 5  | Bodycooling |
| 6  | Volume      |
| 7  | Chanal      |
| 8  | Switch song |
| 9  | Xsens       |
| 10 | Qsens       |

# Control functions

The appliance is set up for standard use with an external timer or a coinbox. If the appliance must function without the external timer or coinbox, i.e. with an internal timer, the required tanning time will have to be adjusted according to the following procedure.

## STARTING THE APPLIANCE IN STAND-ALONE MODE



Press **start/stop**

The display shows the maximum tanning time.

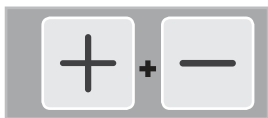

The LEDs above plus/minus flash red.

Set the desired time.



Press **start/stop** to confirm the set time.

The tanning lamps now switch on.

The timer counts down.

## STARTING THE APPLIANCE WITH AN EXTERNAL TIMER OR COINBOX



The appliance will be started automatically if there is no 'remote start' present on the external timer or coinbox.

If this is present, the LED above the start/stop button will flash green. The tanning session begins as soon as the **start/stop** button is pressed. The timer counts up.

**Note:** *If an external timer or coinbox does not have a 'remote start' function and instead the appliance must be started with the start/stop button, this can be configured by your dealer.*

## PAUSE MODE



Press **start/stop**. The lamps are switched off. NOTE! The session time continues counting.

Press **start/stop** again to restart the tanning session.

In stand-alone mode the session can be ended at any time by holding the **start/stop** button for three seconds.

## BODYCOOLING



Press the **body cooling** button.  
The LED above the button begins to flash.

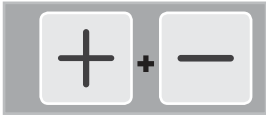

The LEDs above **plus/minus** flash red.  
Set the desired value. The standard value is 1.  
After 5 minutes, you can't turn off the body cooling.

## VOLUME (WITH SOUND SYSTEM ONLY)



Press the **volume** button.  
The LED above the button begins to flash.

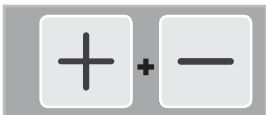

The LEDs above **plus/minus** flash red.  
Set the desired value. The standard value is 4.  
The LED will remain lit as long as the volume button is depressed.

## MUSIC CHANNEL SELECTION (WITH SOUND SYSTEM ONLY)



Press the **channel** button. (option)  
The LED above the button begins to flash.

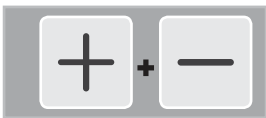

The LEDs above **plus/minus** flash red.  
Set the desired value.  
The LED above channel will remain lit as long as the volume is on.

## SWITCH SONG (WITH SOUND SYSTEM ONLY)



The function is only available if the channel is set to BT, C1 or C2.  
The LED above the button begins to flash.

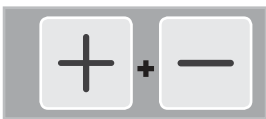

The LEDs above plus/minus flash red.  
The previous or next song can now be selected with the **plus** and **minus** buttons.

*Due to a bug in old Android and Windows Phone software it is possible that this function is not working. To solve this problem: switch off and then back on the Bluetooth\* on the phone. The problem should be solved after reconnecting to the appliance.*

## XSENS (OPTIONAL)



Press the **Xsens** button.  
The text 'ON' now appears on the display; Xsens is on. The LED above Xsens is now on.



Switch off Xsens by pressing the **Xsens** button again.  
The text 'OFF' now appears on the display. The LED above Xsens is now off.

\*The Bluetooth® word mark and logos are registered trademarks owned by Bluetooth SIG, Inc., and any use of such marks by VDL Hapro is under licence.

## QSENS (OPTIONAL)



Press the **Qsens** button.

The text 'ON' now appears on the display; Qsens is on. The LED above Qsens is now on.

Switch off Qsens by pressing the **Qsens** button again.

The text 'OFF' now appears on the display. The LED above Qsens is now off.

**Note:** *If an option is not installed, "NA" appears in the display*

## WARNINGS

Unknown fault, caused by newer control section

Time error in switching section or relay fault

Overheating appliance

Communication error

Internal fault in switching section, sense controller not communicating

Touch panel communication not present

Lamp hours exceeded

See section 'resetting the hour counters' to clear the LH message from the display.

**Note:** *When one of the above-mentioned fault messages appears on the display, you should no longer use the tanning appliance and the plug should be removed from the mains outlet. Contact your dealer. (This does not apply to the LH message.)*

## AMBIENT FLOWLIGHT SWITCH OFF (OPTIONAL)



To switch off the Ambient Flowlight, hold the **bodycooler** button for five seconds.

Press **any** button to switch the Ambient Flowlight back on.



# Reading the hour counters and software versions

## STATUSMENU

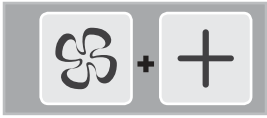

Hold the **body cooling** and **plus** buttons for five seconds.  
You now see the unit status menu.  
The hour counters and software versions can be viewed here.

## RESETTING THE HOURS COUNTERS



Select LH.



Hold the **start/stop** button for three seconds.  
Enter the PIN code and press start/stop. It is set to 000 by default.  
The hour counters are reset.

# Maintenance

## CLEANING

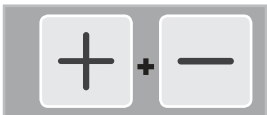

The tanning appliance is equipped with a touch panel control. To prevent accidental operation of the machine during cleaning, you can temporarily switch off the control.  
Hold the **plus** and **minus** buttons for five seconds.

The display counts down from 60 to 0.  
During this period the display cannot be operated.  
The time you have to clean the machine can be changed.  
The standard cleaning time is 1 minute.

## REPLACING THE QSENS (OPTION) LIQUID JUG

Never refill your Qsens liquid jug with regular tap water or any other liquid. Replace with an original Hapro Sanitized Qsens liquid jug. Remember to order the Qsens liquid jugs in time. Before Qsens can be used for the first time or after replacement of the liquid jug, the system must be bled of air.

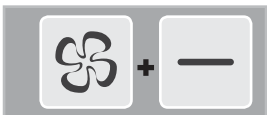

Hold the **body cooling** and **minus** buttons for five seconds.  
Enter the PIN code; it is set to 000 by default. Press **start/stop** to confirm the PIN code.  
You are now in the parameter menu.

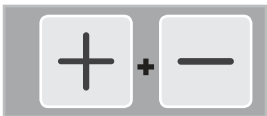

Navigate to '05 - Qsens' with **plus** and **minus**, and press start/stop to confirm your choice.  
Navigate to '03 - Qsens initialization' with **plus** and **minus**, and press **start/stop** to confirm your choice.  
Navigate to 'YES' with **plus** and **minus** to immediately start the initialization.

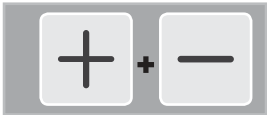

Wait until the Qsens nozzles produce a fine mist of water.  
Press **plus** or **minus** to stop the initialization.



Press 3x the **body cooling** button to exit the parameter menu.  
Your Qsens set is now ready for use.

## REPLACING THE XSSENS (OPTION) CARTRIDGES

If you purchased an Xsens I set, you can replace an empty can with a full one.

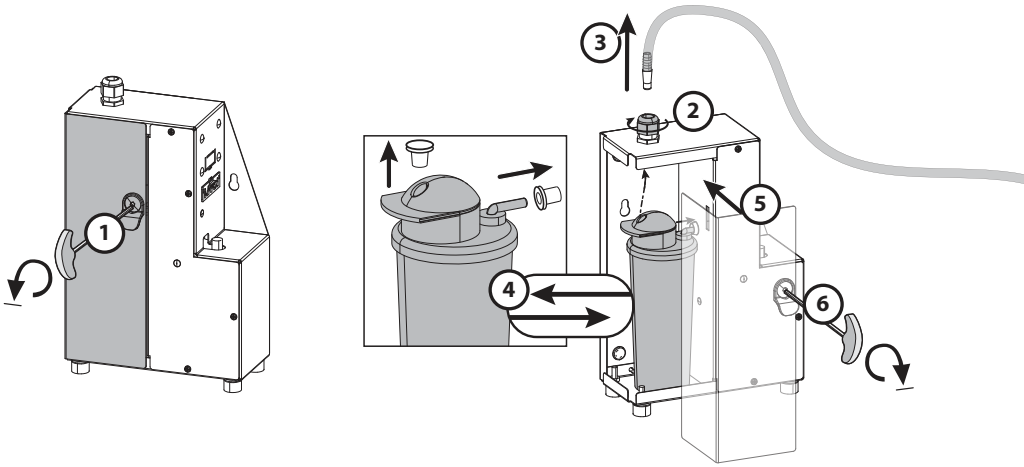

## CHANGING SOUNDAROUND (OPTION) MEMORY CARDS

You can replace your SmartVoice card with a different SmartVoice card.

You can place your own music on the Studio card or Wellness card. Only use the supplied memory cards.

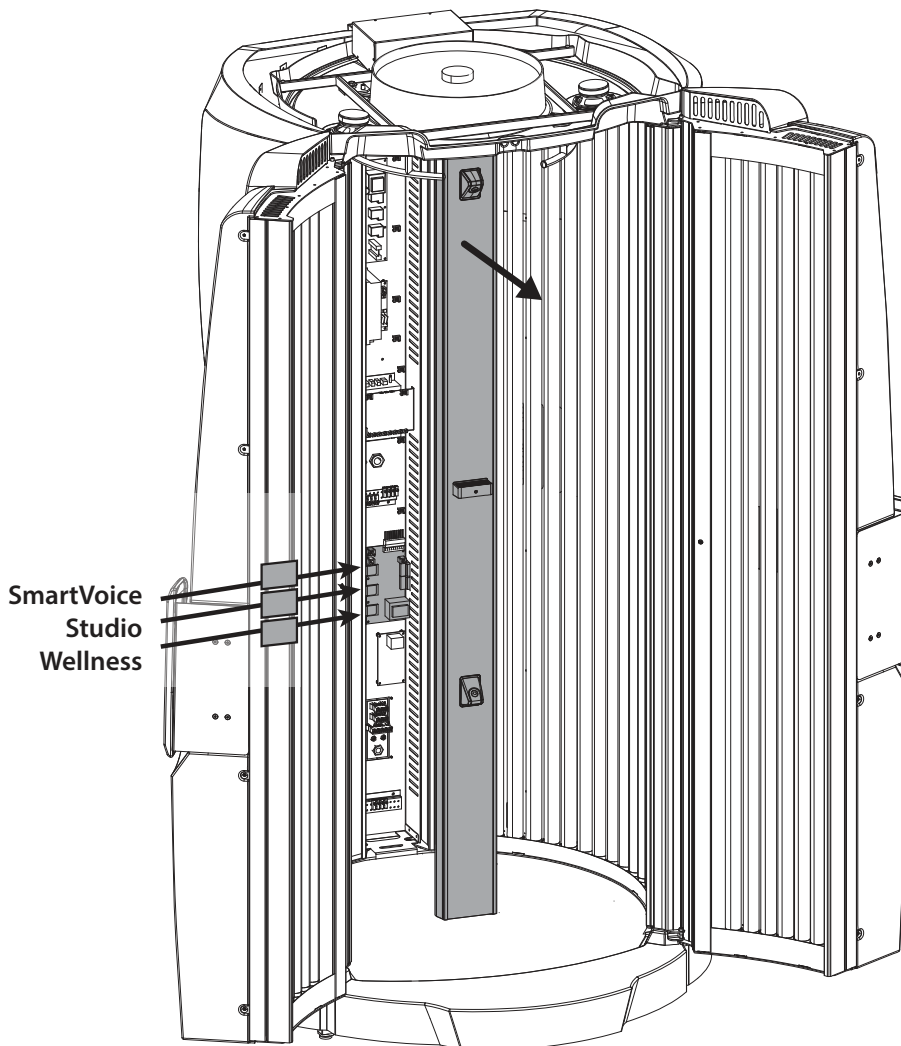

# Tanning appliance settings

## PARAMETERMENU

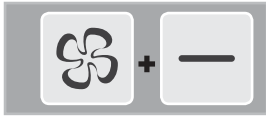

Hold the **body cooling** and **minus** buttons for ten seconds.  
Enter the PIN code; it is set to 000 by default.

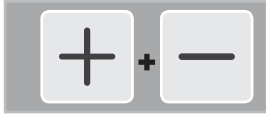

You can change the value of the digit with **plus** and **minus**.



Press the **body cooling** button to proceed to the next digit.



Press **start/stop** to confirm the PIN code.

## PARAMETERS

The sunbed can be set to your preferences by changing the parameters shown here. The parameters that are not shown in the table may only be changed by your dealer.

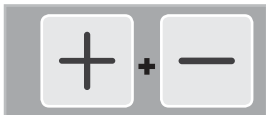

Navigate to the desired submenu with **plus** and **minus**, and press start/stop to confirm your choice.  
Press the **body cooling** button to return to stand-by.

Navigate to the desired parameter menu with **plus** and **minus**, and press **start/stop** to confirm your choice.  
Press the **body cooling** button to return to the parameter menu. Use **plus** and **minus** to change the value.



Save the new value with **start/stop**. You now return to the submenu.



Press the **body cooling** button to cancel the new value. You now return to the submenu.

**Note:** If no button is pressed for one minute, you automatically return to the stand-by screen.

DISPLAY			DEFAULT
	1	<b>Unit</b>	
	1	Start time (minutes)	0 = Coin unit / 1 - maximum time = Stand alone 0
	2.	Maximum time	Time at which the decorative lighting is switched on 30 (min.)
	3.	Special mode	1 = Restore factory settings / 6 = Reset TL hour meter 0
	4.	Pin code	Unique code for entering the parameter menu 000
	5.	Usefull life lamps	Step Size: 100 hours. 0 = no message 0 (hours)
	6.	Clean time (minutes)	The length of time the display is switched off for cleaning 1 (min.)
	2	<b>Bodycooler</b>	
	1	Bodycooler at start	Speed of the body cooler at the beginning of the session 1
	3	<b>Xsens</b>	
	1	Xsens available	Off
	2.	Xsens at start	Xsens scent at the beginning of the session (0 = off) Off
	4	<b>SoundAround</b>	
	1	My MP3 input present	On

	2.	Wellness card present		On
	3.	Studio card present		On
	4.	Bluetooth ID code	ID on smartphone: LUXURA ##	00
	5.	Bluetooth PIN code	Pincode Bluetooth connection	000
	6.	Number of external music channels		0
	7.	Smartvoice language		2
	8.	Volume My MP3 input		32
	9.	Volume My Bluetooth		32
1	0.	Volume Wellness card		30
1	1	Volume Studio card		30
1	2.	12-19 Volume channel 1/ channel 8		26
2	0.	SmartVoice volume		26
2	1	Tone high		9
2	2.	Tone low		11
2	3.	Standby volume		0
2	4.	Standby channel	<b>0</b> = MP3 input (Display: np3) <b>1</b> = Bluetooth (Display: bt) <b>2</b> = Wellness card (Display: C1) <b>3</b> = Studio card (Display: C2) <b>4-11</b> = Studio channel (Display: C3-C10)	2
2	5.	Start volume		4
2	6.	Start channel	<b>0</b> = MP3 input (Display: np3) <b>1</b> = Bluetooth (Display: bt) <b>2</b> = Wellness card (Display: C1) <b>3</b> = Studio card (Display: C2) <b>4-11</b> = Studio channel (Display: C3-C10)	3
2	7.	Start audio volume		On
	5	<b>Qsens</b>		
	1	Qsens at start	State of the Qsens at the beginning of the session	Off
	3.	Qsens initialization	Bleeding of the Qsens system	Off
	7.	Spray time nozzle 1		4 (sec.)
1	0.	Interval time Qsens session		2 (min.)
	6	<b>Coin</b>		
	1	Relais puls		1 (sec.)
	2.	Direct on	Whether or not turn on directly after coin signal	On
	3.	ATF Mode		Off
	7	<b>Ambient Flowlight</b>		
	1	Effect	Colour programme	1
			0 = single color (see color sub: 4. color number)	
			1 = all colors	
			2 = base colors quickly	
			3 = base colors slowly	
			4 = shades of white	
			5 = soft colors	
			6 = shades of white (base white)	
			7 = shades of red, orange and yellow	
			8 = shades of purple and pink	
			9 = shades of red	
			10 = shades of orange	
			11 = shades of yellow	
			12 = shades of green	
			13 = shades of blue	
			14 = shades of purple	
			15 = shades of pink	
	2.	Effect speed	Speed at which the colour programme cycles (1-20)	10
	3.	Ambient Flowlight at start	Decorative lighting at the beginning of the session	On
	4.	Color number	Colour	27

		0 = off	
		1 = red	
		3 = orange	
		5 = yellow	
		7 = bright green	
		11 = green	
		15 = ice blue	
		20 = blue	
		23 = purple	
		28 = pink	
		30 = dark red	
		31 = white	

# Symbols

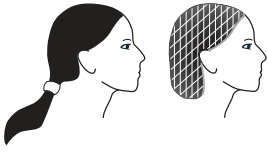

*Warning symbol:*

**People with long hair should wear a hairnet!**



*Warning symbol:*

**Wear the protective goggles provided**



*Warning symbol:*

**Attention please!**



*Warning symbol:*

**Sunbed should be disconnected from power source**



*Warning symbol:*

**Remove plug from socket**



*Warning symbol:*

**Not for household use**



*Symbol:*

**Facial tanner**



*Symbol:*

**Vertical sunbed**



*Symbol:*

**Only applicable if this option is ordered**

## Warranty

Our appliances are manufactured with the greatest attention and are of excellent quality.

Every Luxura appliance is manufactured to meet the international IEC/EN standards and carries the Kema seal of approval. We provide a manufacturer's warranty of 1 year.

Your new appliance has a manufacturer's guarantee of 1 year, which commences on the date of installation. Within the warranty period all faults that are the result of material or manufacturing errors will be repaired at no cost. Please contact your dealer for any warranty enquiries.

In order to make a claim under the terms of this

guarantee, you must be able to produce the original invoice or receipt bearing the date of purchase. The type and serial number of the appliance should also be indicated.

The warranty is subordinate to the national regulations on product warranties.

## Not covered under this warranty

Units which have the type, serial number and/or other identification labels removed, damaged or altered.

Lamps, starters and acrylic sheets.

Damage due to purchaser abuse, neglect, transport, improper use or improper maintenance.

Damage due to use of accessories not originally supplied by Hapro or inferior accessories.

Damage due to installation, repair or assembly not done by Hapro authorised personnel.

Damage due to fire, lightning, earthquakes or other natural disasters.

**Manufacturer**

VDL Hapro bv  
Fleerbosseweg 33  
4420 AC Kapelle, The Netherlands  
www.vdlhapro.com

**Product identification**

Product: Tanning equipment  
Model: Luxura V6  
Type: 42 XL Intensive, 42 XL High Intensive,  
42 XL Ultra High Intensive, 44 XL Intensive,  
44 XL High Intensive, 44 XL Ultra Intensive  
48 XL Ultra High Intensive

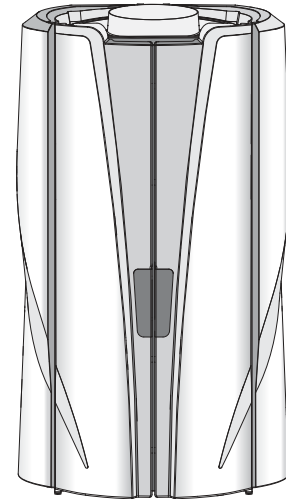

This document is valid for all above mentioned  
types produced from:  
02/11/2014

**Means of conformity**

The products are in conformity with Directive 2004/108/EC of the European Community and the Low-Voltage Directive 2006/95/EC of the European Community.

**Testing, Electro-Magnetic Compatibility**

Carried out by: VDL Hapro Laboratory  
Fleerbosseweg 33  
4420 AC Kapelle, The Netherlands  
Standards used: EN 61000-6-3:2007+A1: 2011; EN 55014-1:2006+A1:2009, +A2:2011  
EN 61000-3-2:2006+A1:2009, +A3:2009; EN 61000-3-3:2008;  
EN 61000-6-1:2007; EN 61000-4-2:2009; EN 61000-4-3:2006+A1:2008,  
+A2:2010; EN 61000-4-4:2012; EN 61000-4-5:2006; EN 61000-4-6:2009;  
EN 61000-4-8:2010  
2112431.0551-QUA/EMC

**Testing, Low-Voltage Directive**

Carried out by: VDL Hapro Laboratory  
Fleerbosseweg 33  
4420 AC Kapelle, The Netherlands  
Standards used: EN 60335-1:2012/C11:2014  
EN 60335-1:2012/A11:2014  
EN 60335-2-27:2014



**Representative**

Name: D.C. van de Linde  
Function: Managing Director  
Date: 02-11-2014  
Signature:





## Manufacturer

VDL Hapro bv  
Fleerbosseweg 33  
4420 AC Kapelle, The Netherlands  
www.vdlhapro.com

## Product identification

Product: Tanning equipment  
Model: Luxura V8  
Type: 48 XL Intensive, 48 XL High Intensive,  
48 XL Ultra High Intensive

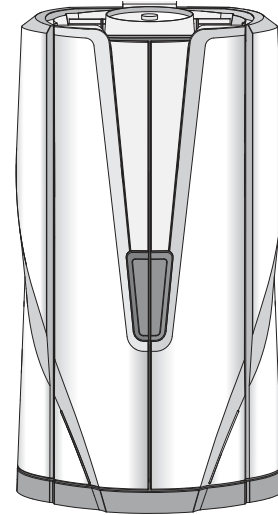

This document is valid for all above mentioned  
types produced from:  
02/11/2014

## Means of conformity

The products are in conformity with Directive 2004/108/EC of the European Community and the Low-Voltage Directive 2006/95/EC of the European Community.

## Testing, Electro-Magnetic Compatibility

Carried out by: VDL Hapro Laboratory  
Fleerbosseweg 33  
4420 AC Kapelle, The Netherlands

Standards used: EN 61000-6-3:2007+A1:2011; EN 55014-1:2006+A1:2009, +A2:2011  
EN 61000-3-2:2006+A1:2009, +A3:2009; EN 61000-3-3:2008;  
EN 61000-6-1:2007; EN 61000-4-2:2009; EN 61000-4-3:2006+A1:2008,  
+A2:2010; EN 61000-4-4:2012; EN 61000-4-5:2006; EN 61000-4-6:2009;  
EN 61000-4-8:2010  
2112431.0551-QUA/EMC

## Testing, Low-Voltage Directive

Carried out by: VDL Hapro Laboratory  
Fleerbosseweg 33  
4420 AC Kapelle, The Netherlands

Standards used: **EN 60335-1:2012/C11:2014**  
**EN 60335-1:2012/A11:2014**  
**EN 60335-2-27:2014**



## Representative

Name: D.C. van de Linde  
Function: Managing Director  
Date: 02-11-2014  
Signature:







**VDL Hapro** 

VDL Hapro bv, P.O. Box 73, 4420 AC Kapelle, The Netherlands, [www.vdlhapro.com](http://www.vdlhapro.com)